



PCR-1Z-SM PCR-1Z PCR-2Z
 PCR-1ZW PCR-2ZW

Installation and Operations Manual



64-PCR-1Z-16	PAL 16W Multi Color Single Zone Remote Control Transformer 24VDC
64-PCR-1Z-65	PAL 65W Multi Color Single Zone Remote Control Transformer 24VDC
64-PCR-2Z-65	PAL 65W Multi Color Dual Zone Remote Control Transformer 24VDC
64-PCR-1ZW-16	PAL 16W Multi Color Single Zone Remote Control Transformer & WI-FI 24VDC
64-PCR-1ZW-65	PAL 65W Multi Color Single Zone Remote Control Transformer & WI-FI 24VDC
64-PCR-2ZW-65	PAL 65W Multi Color Dual Zone Remote Control Transformer & WI-FI 24VDC
64-PCR-1Z-SM-16	PAL 16W Switch Mode Multi Color Single Zone Remote Control Transformer 24VDC
64-PCR-1Z-SM-65	PAL 65W Switch Mode Multi Color Single Zone Remote Control Transformer 24VDC

PAL Lighting LLC
 4830 Timber Creek Dr, Houston, TX 77017
 North America: +1 (713)-946-4343
www.pallighting.com

CONTENTS	
Preparation	p3
Hardware Installation	p4
Clone Settings	p7
PCZ Transmitter Remote	p9
Setting Up your Color Touch App	p10



IMPORTANT INFORMATION

Improper installation carries the potential for electrical hazards, presenting a risk of severe or even fatal injuries to pool users, installers, or bystanders due to the threat of electrical shock, and may also result in property damage.

For your safety, it is imperative that this product be installed and maintained by a licensed and qualified contractor specializing in pool equipment, adhering to local regulations. The individual responsible for maintenance should possess extensive experience in pool equipment installation and upkeep to ensure precise adherence to the instructions outlined in this manual. Prior to installation, thorough comprehension, and compliance with all provided warning notices and instructions are crucial. Failure to do so may lead to property damage, personal injury, or loss of life. Any improper installation and/or operation may void the product's warranty and pose significant electrical hazards, potentially resulting in severe harm, property damage, or fatality. It is strictly advised not to modify this equipment. Installer, please be aware that this manual contains vital information concerning the installation, operation, and safe utilization of this product, which should be communicated to the equipment's owner/operator.

PREPARATION

This manual provides installation and operational instructions for the PAL Lighting PCR-1Z, PCR-2Z, PCR-1ZW, PCR-2ZW & PCR-1Z-SM Lighting Controllers.

Read the installation & operational manual before proceeding with the installation. Keep this manual for future reference.

Before starting the installation, check that you have the correct parts below. If any parts are missing, please call technical support at [+1 \(713\)-946-4343](tel:+17139464343).

PACKAGE CONTENTS

PAL Driver *remote and wifi module included with select models.

IMPORTANT NOTICE

No bonding is required from this Class 2 power supply to the UL Listed PAL Pool Light fixtures as they are made of an all-plastic construction and comply with the NEC article 680 requirements.

PREPARATION WORK

1. The PCR-1Z, PCR-1ZW, and PCR-1Z-SM lighting controllers are specifically designed to supply 24V DC to power the PAL 4 Wire UL Listed Pool Lights.
2. Please note that PCR-1Z-SM cannot be upgraded to Wi-Fi or Remote use without the purchase of a PCR-1Z or PCR-2Z driver.
3. The PCR-1Z-SM, PCR-1Z, PCR-2Z, PCR-1ZW, and PCR-2ZW lighting controllers must be installed in accordance with the National Electrical Code (NEC) by a certified electrician or qualified pool technician.

HARDWARE INSTALLATION

HARDWARE INSTALLATION INSTRUCTIONS FOR RGB LIGHTING CONTROLLERS

1. The PCR -1Z-SM/PCR-1Z/PCR-2Z Class 2 Power Supply is a weatherproof construction (IP65) and should be mounted on a flat surface using the mounting legs on the enclosure with appropriate fixtures for the mounting substrate and in a suitable position to suit the intended location of the PAL 4 Wire LED Pool Lights and installed to comply with all the requirements of the National Electrical Code (NEC) and all relevant local codes and ordinances.

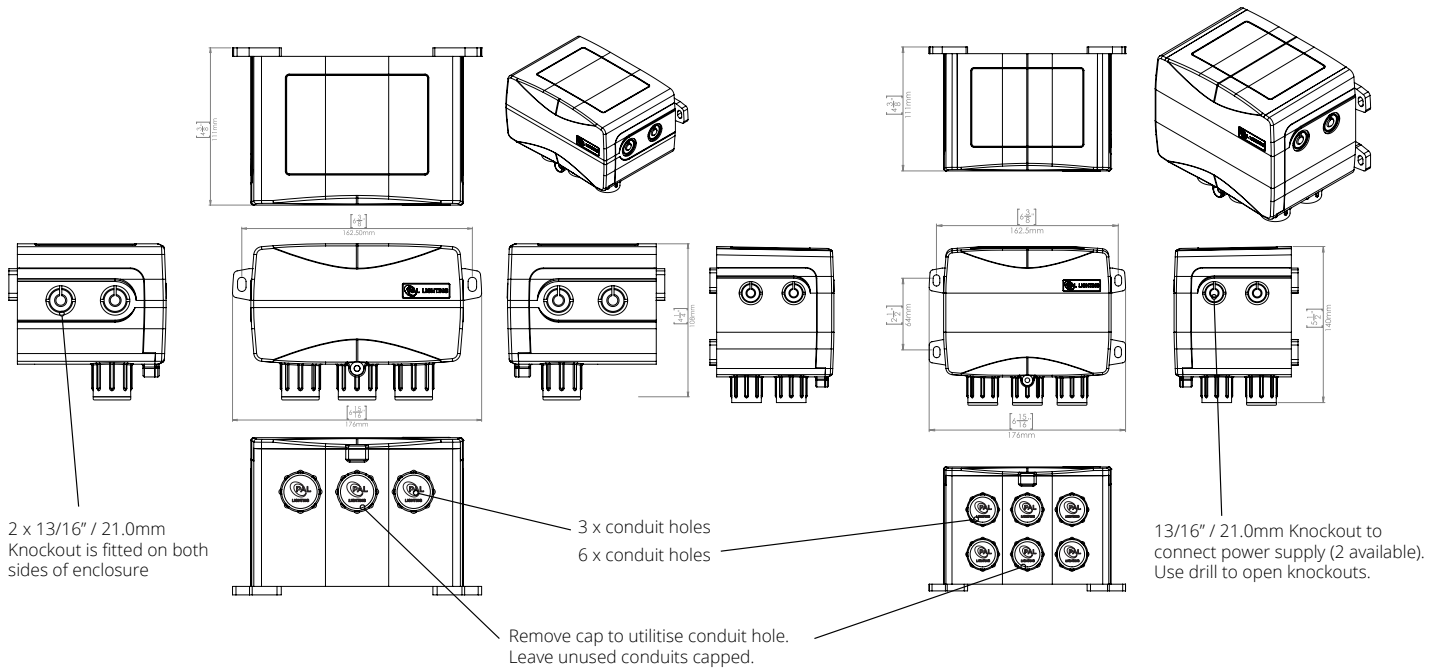

Knockout Instructions

It is recommended that the cover is fitted and the cover screws tight when the knockouts are being removed.

When removing the knock outs place a flat blade screwdriver with a 3/16" (4mm) blade as shown and a light hit with a hammer to the head of the screw driver will allow the Knockout to be removed.

Alternatively drill location points are located in the centre of each Knock out to allow the use of a hole saw to remove the knockouts.

NOTE: The driver enclosure should be placed a minimum of 5 feet away from the inner pool wall horizontally and should sit no lower than 1 foot above the maximum water level of the pool, measured up to the top of the enclosure.

NOTE: To properly install the enclosure, utilize its mounting legs and the provided screw set. If mounting on a concrete or block wall, mark the hole locations, drill 3/16" holes with a masonry drill, insert the provided Star Plugs into the holes, and secure them using the stainless-steel screws provided.

2. Using the conduit entry on the bottom (bottom-front on PCR-2Z) right hand side of the PCR-1Z-SM/PCR-1Z connect the 100-120V power supply to NEC code requirements.

3. Using the remaining conduit entries at the bottom of the driver, connect the 4-core wire from the PAL 4 WIRE LED LIGHTS. Please ensure the 4 cores are connected to the correct terminals. The enclosure includes 2 output conduit entries designed for connecting to 2 PAL-LED 4 Wire Pool Lights.

4. The Lighting Controller is factory set to operate with the PCZ-2 Transmitter supplied. Simply fit the two batteries included with the PCZ-2 Transmitter. The PCR-1Z-SM does not operate with the PCZ-2 Transmitter. Please refer to the information supplied with the PCZ-2 Transmitter for full operating instructions and features of the system.

INSTALLATION INSTRUCTIONS FOR V3 PCR-1Z-SM RGB OUTDOOR DRIVER

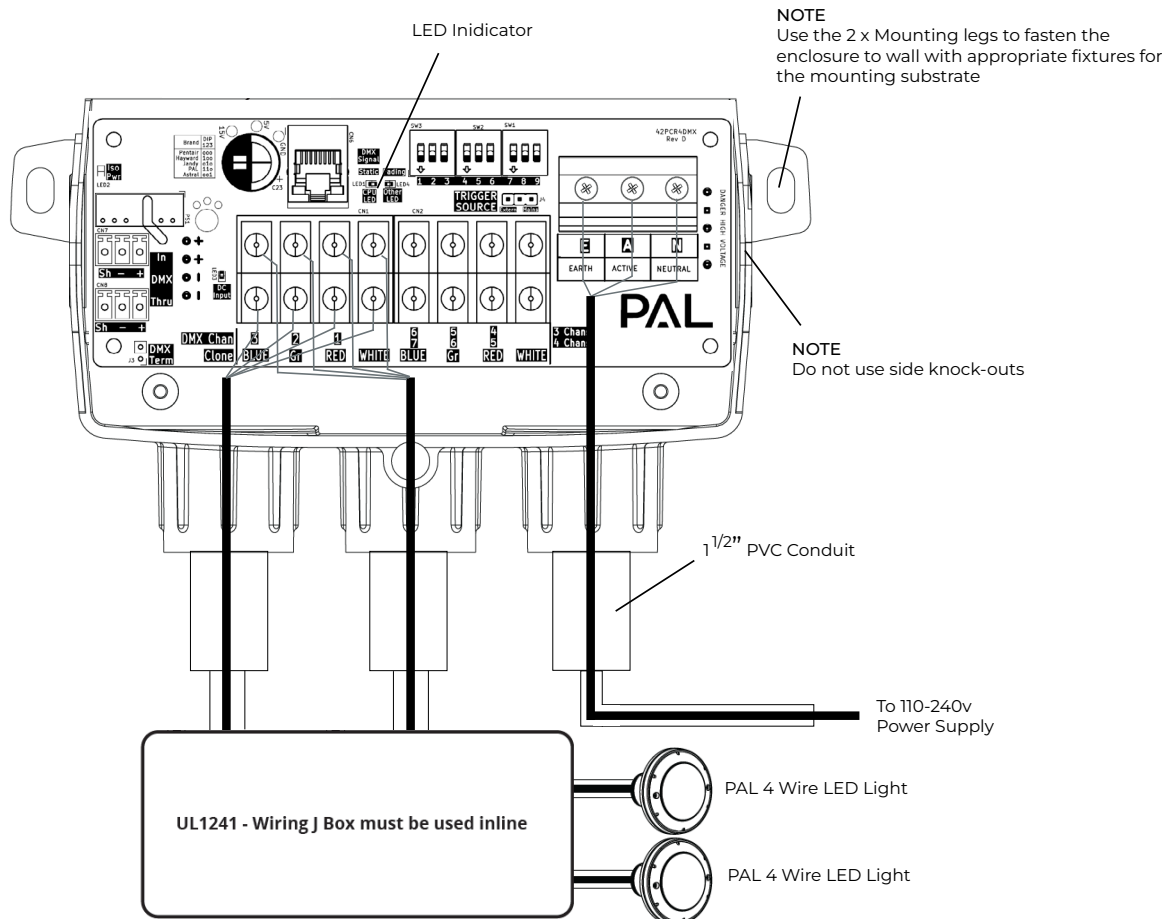

The switch mode V3 control board is "DMX ready" which is designed to help with future-proofing the installation to better suit upgrades. However, for switch mode lighting controllers please ignore all DMX terminology and switch configurations.

“Long Strip” Mode

Dipswitch #9 toggles “long strip” mode. This is used when an LED strip is used for long lengths. Pool perimeter, long hardscape runs, etc.

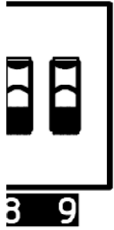

Mode	#9	Note
Long Strip Off	Off	Normal
Long Strip On	ON	The output is altered to better suit long RGB strips.

Long strip mode will lower overall brightness to better suit longer strip runs. The length is strip dependant although 30+ feet is a good general guideline.

Trigger Source

If AstralPool Automation Systems are being used, the jumper bridge at “TRIGGER SOURCE”/J4 must be moved to connect pins #1 and #2 - otherwise



The RJ12 connection is live and an additional AstralPool system PCB/module can be connected.



MOST scenarios - NEVER move the bridge jumper unless specifically using AstralPool Automation systems.

Software Information

The CPU LED will typically show red color. This will also provide software information at bootup/restart.

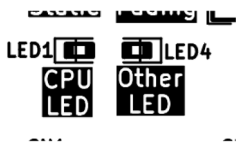

CPU LED uses short pulses to indicate numbers. (I.E. 2 short pulses indicates the number 2.)

Other LED uses a long pulse to indicate a decimal.

Example:
2 short pulses on the CPU LED followed by 1 long pulse on the Other LED followed by 1 short pulse on the CPU LED indicates 2.1

INSTALLATION INSTRUCTIONS FOR V2 PCR-1Z-SM & PCR-1Z RGB OUTDOOR DRIVER

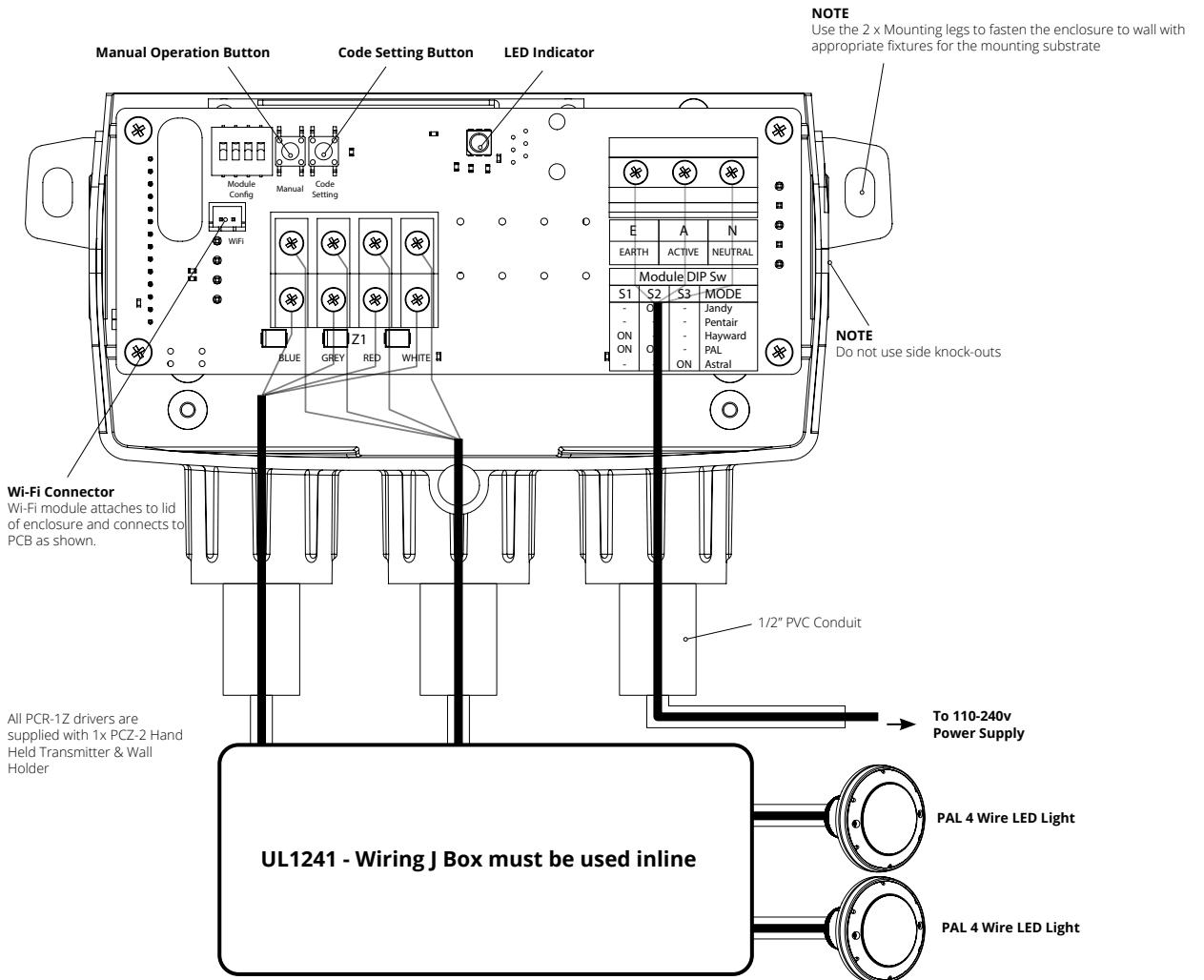

INSTALLATION INSTRUCTIONS FOR PCR-2Z RGB OUTDOOR DRIVER

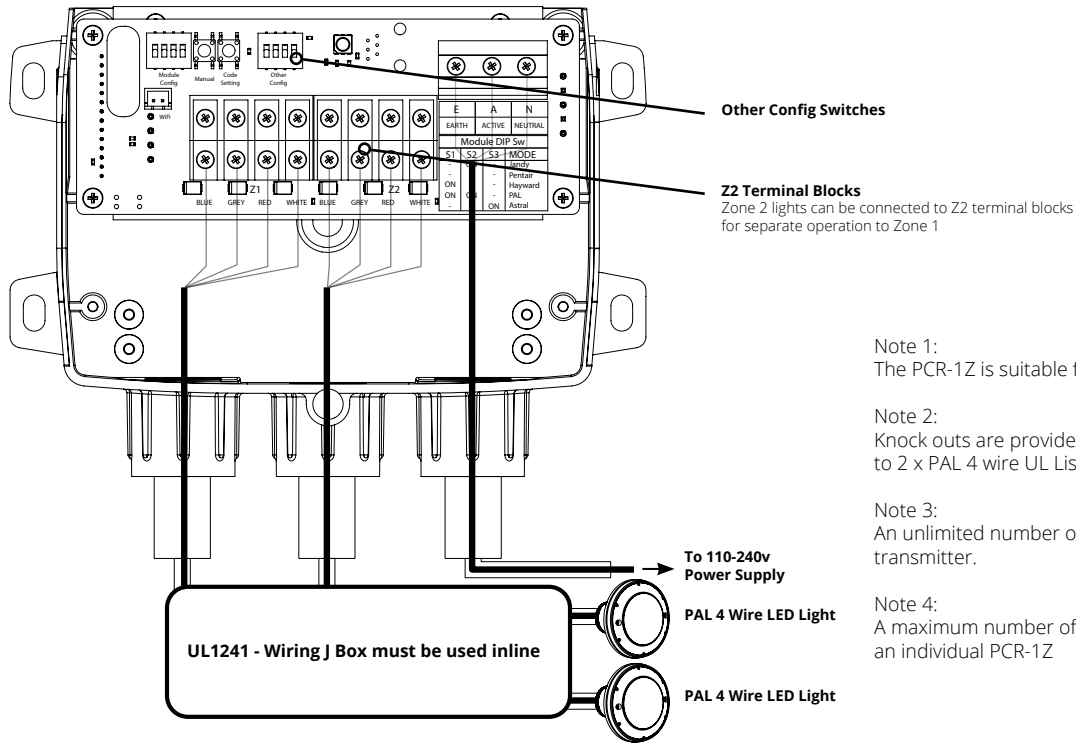

Note 1:
The PCR-1Z is suitable for PAL 4 wire lights.

Note 2:
Knock outs are provided in the enclosure to connect up to 2 x PAL 4 wire UL Listed Pool Lights.

Note 3:
An unlimited number of drivers can be controlled by one transmitter.

Note 4:
A maximum number of 4 x Transmitters can be coded to an individual PCR-1Z

CLONE SETTINGS

CLONING SETTINGS (V3 PCR-1Z-SM)

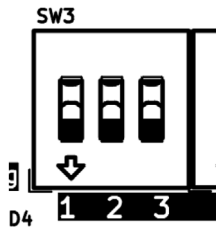

Switch 1	Switch 2	Switch 3	Mode
OFF	ON	OFF	Jandy
OFF	OFF	OFF	PENTAIR
ON	OFF	OFF	HAYWARD
ON	ON	OFF	PAL LIGHTING
ON	ON	ON	ASTRALPOOL

CLONING SETTINGS (V2 PCR-1Z-SM, PCR-1Z & PCR-2Z AUTOMATION)

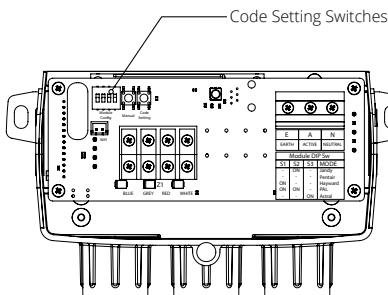

Switch 1	Switch 2	Switch 3	Switch 4	Mode
OFF	ON	OFF	ON	Jandy
OFF	OFF	OFF	ON	PENTAIR
ON	OFF	OFF	ON	HAYWARD
ON	ON	OFF	ON	PAL LIGHTING
OFF	OFF	ON	ON	ASTRALPOOL

Note:

- Must turn off power before making DIP switch selection.
- When synching PAL lights to other OEM lights, static colors will match but color change mode timing may vary.
- If the PAL Lights are to be used with Automation, do not use the handheld remote control and disconnect the WiFi module from the board if so equipped.
- If the Automation does not turn the PAL lights on or off and there is power to the driver, press the Z1 button one time to turn on the PAL Driver.
- Note that the PAL features of infinite color selection and dimmability are not available while in Cloned mode.

ZONE SETTINGS - PCR 2Z ONLY

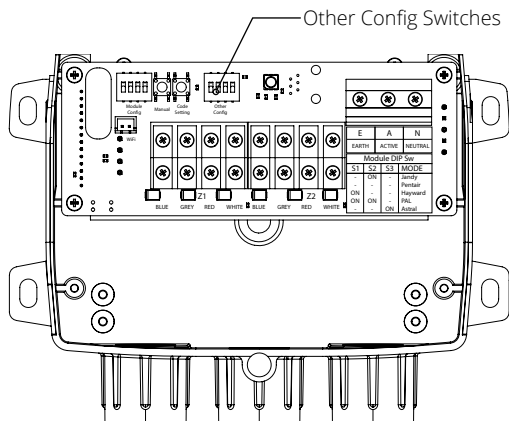

Switch 3	Switch 4	Mode
OFF	OFF	6000K
ON	OFF	5000K
OFF	ON	4000K
ON	ON	3000K

Other Config Operation

- Must turn off power before making DIP switch selection.
- Dip Switch 2: Toggles between 1 and 2 zone operation
- Dip Switch 1: When in single zone mode, this switch selects whether the driver operates entirely as Z1 or Z2 on the remote.
- Dip Switches 3 & 4 change the approximate color temperature of mixed white lights.

Switch 1	Operation
ON	Zone 2
OFF	Zone 1

Switch 2	Operation
ON	Single Zone Operation
OFF	Two Zone Operation

ZONE SETTINGS - V2 PCR-1Z-SM ONLY

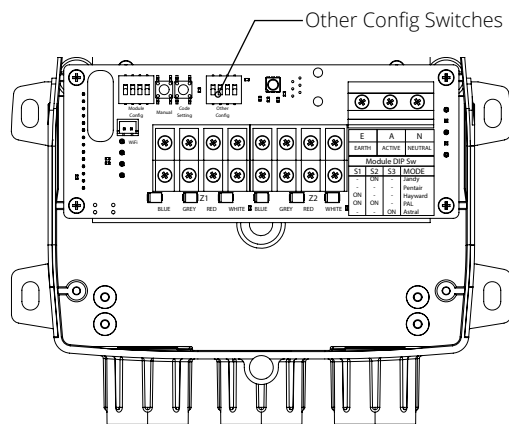

Switch 1	Operation
ON	Zone 2
OFF	Zone 1

Switch 3	Mode
OFF	6000K
ON	5000K
OFF	4000K
ON	3000K

Other Config Operation

- Must turn off power before making DIP switch selection.
- Dip Switch 2: Toggles between 1 and 2 zone operation
- Dip Switch 1: When in single zone mode, this switch selects whether the driver operates entirely as Z1 or Z2 on the remote.
- Dip Switches 3 & 4 change the approximate color temperature of mixed white lights.

Switch 2	Operation
ON	Single Zone Operation
OFF	Two Zone Operation

AUTOMATION DEDICATED LIGHT OUTPUT RELAY FOR CLONE MODE

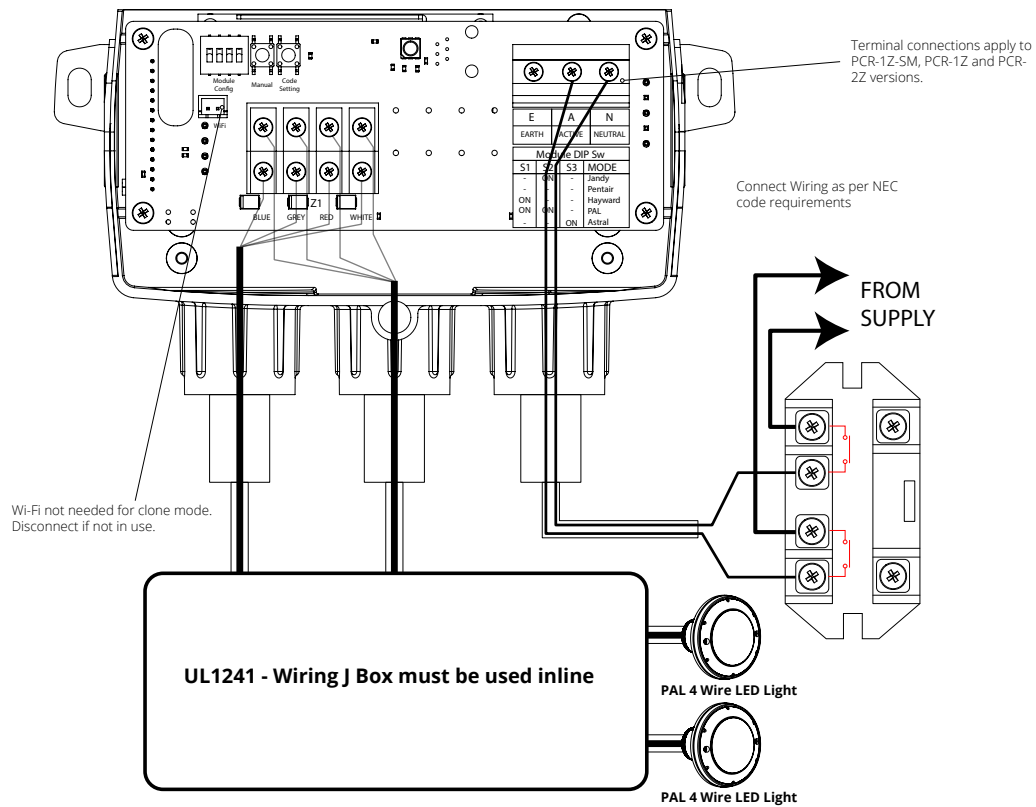

PCZ TRANSMITTER REMOTE

PAL TOUCH PCZ-2 TRANSMITTER HAND HELD REMOTE

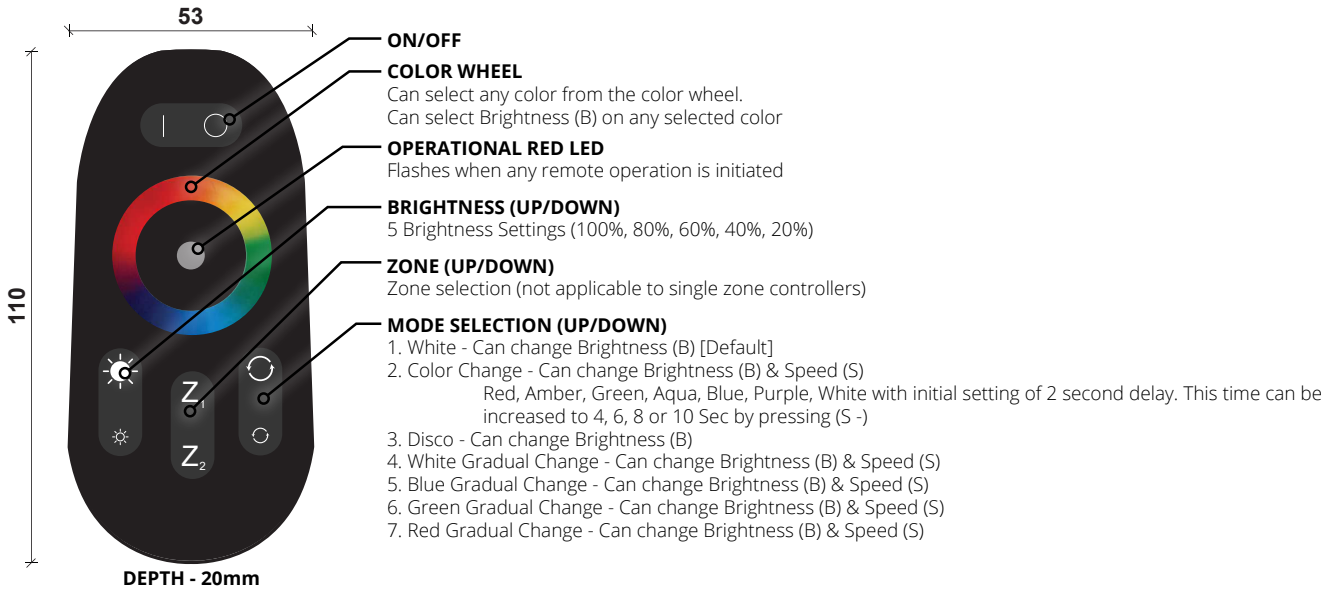

FEATURES

1. Matching Code - Apply power to the receiver. Then press Z₁ once within 5 seconds. The output light will flash white 3 times if matching is successful.
2. Clearing Code - Apply power to the receiver. Hold down Z₁ for 3 seconds. The output light will flash 6 times if clearing the code is successful. After successfully clearing the existing code a new code will have to be applied by following the matching code procedure above.
3. 1 Transmitter (PCZ-2) can operate an unlimited number of Receivers (PCR-1Z)
4. 1 Receiver (PCR-1Z) can be controlled by a maximum of 4 Transmitters (PCZ-2)
5. Touching the color wheel will reset any Mode selection.
6. Memory Feature - Remembers color selection after being switched off.
7. Once the transmitter and receiver are successfully coded the receiver will remember the code if powered off.

SETTING UP YOUR COLOR TOUCH APP

PCR-1ZW / PCR-2ZW WIFI ONLY

Creating a New Login

1. If you have not already done so, create an account.
2. If you have not already done so, accept all permissions.

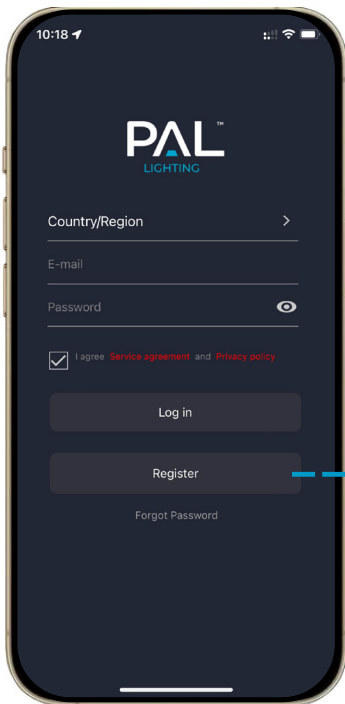

NEW ACCOUNT SETUP

Step 1 Select 'Register'

Step 2 Enter homeowner's email

Step 3 Select 'Get'

(A verification code will be sent to the email address)

Step 4 Enter the verification code

Step 5 Click 'Next'

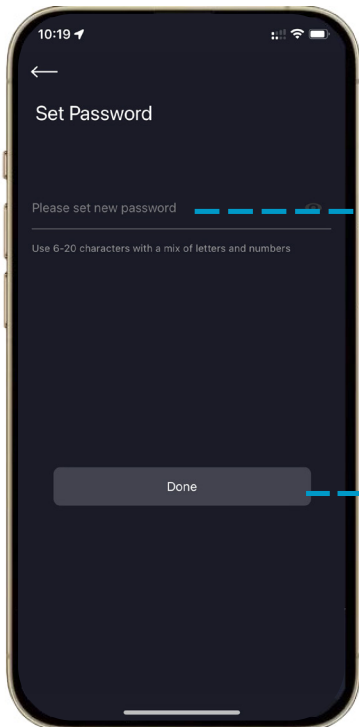
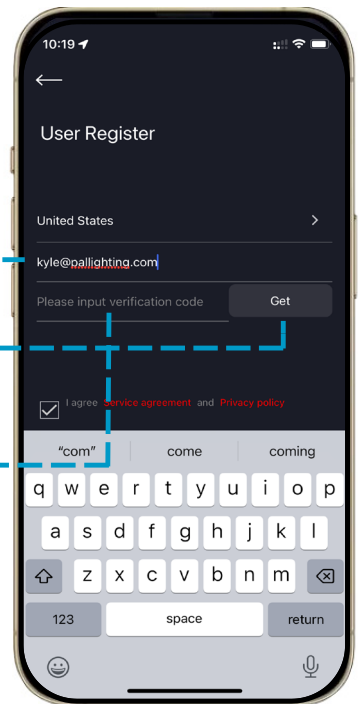

NEW ACCOUNT SETUP

Step 1 Enter Password

Step 2 Select Done

Step 3 Select 'Allow'

Step 4 Select 'Register'

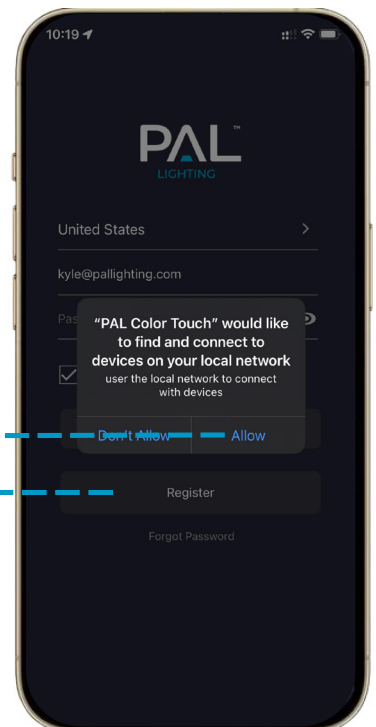

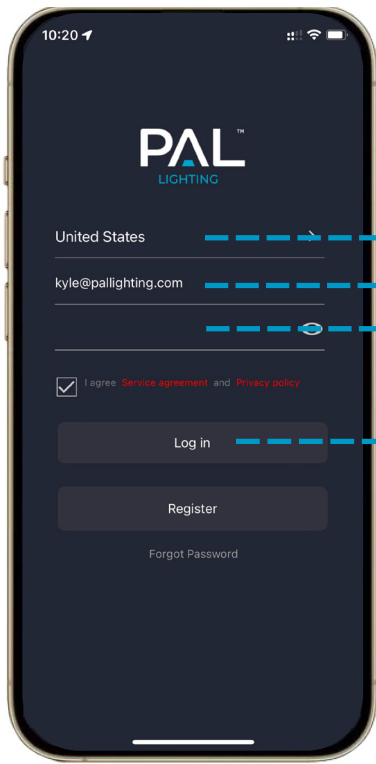

LOGGING IN

- Step 1** Select Country
- Step 2** Done
- Step 3** Enter Password
- Step 4** Select 'Login'

Connecting to a New Driver

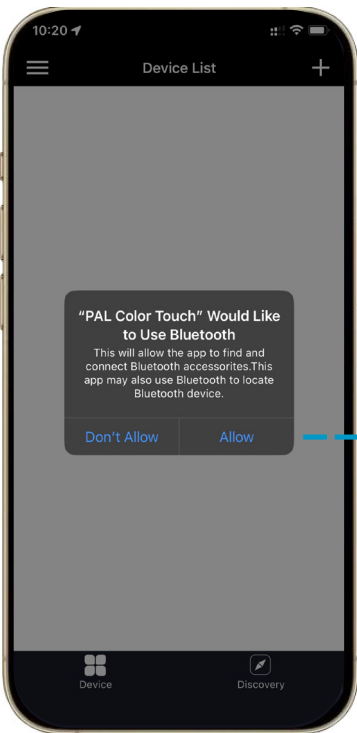

- Step 1** Select 'Allow'
- Step 2** Select '+'

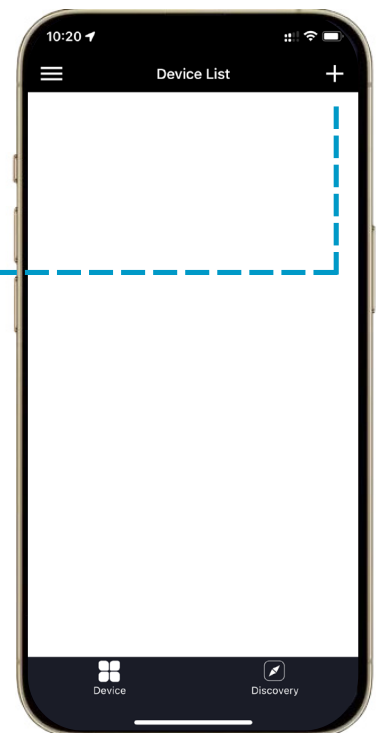

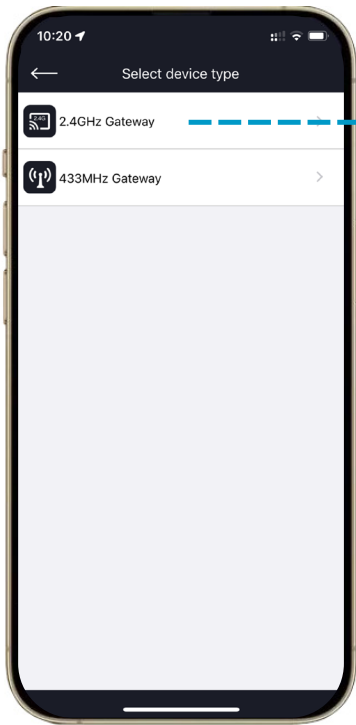

Step 1 Select 'Allow'



Step 1 Select 'Allow'

Step 2 Hold 'Reset' button for 3 seconds until light starts to flash

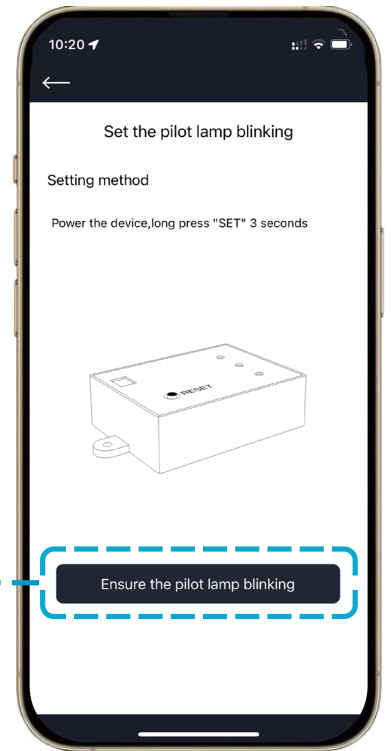

Ensure the pilot lamp blinking

Updating the App

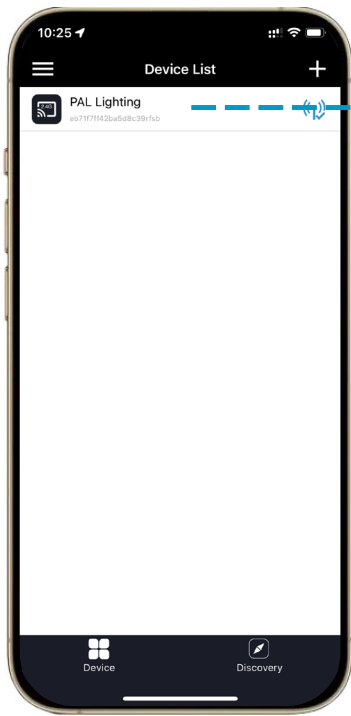

Step 1 Select Driver

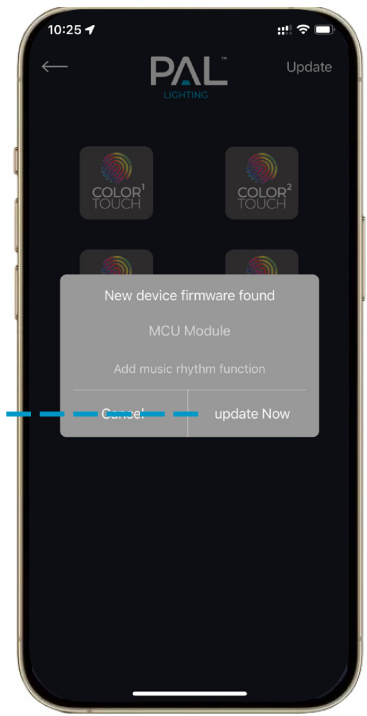

Step 2 Select 'Update Now' (if necessary)

Updating the Color Touch App

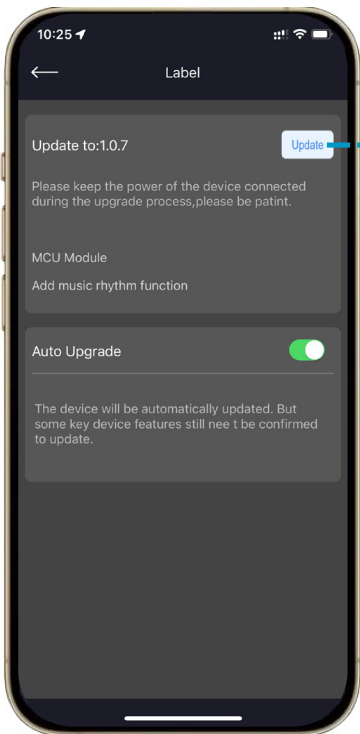

Select Update

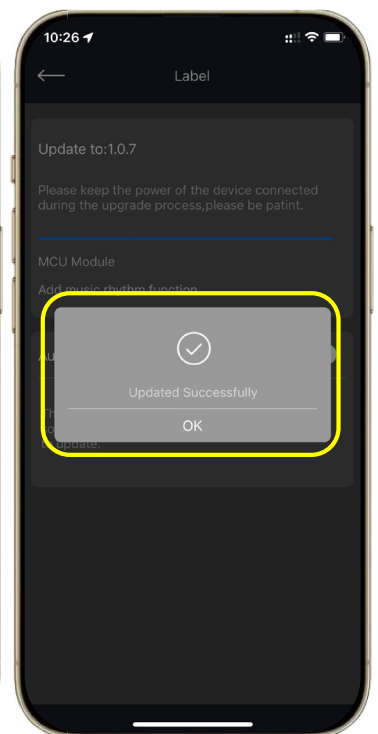
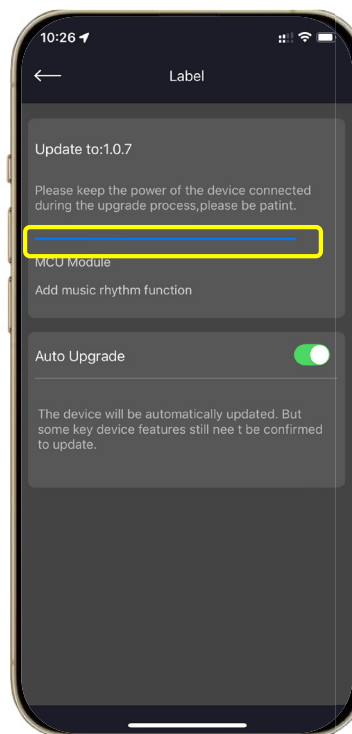

Setting Up a New Driver

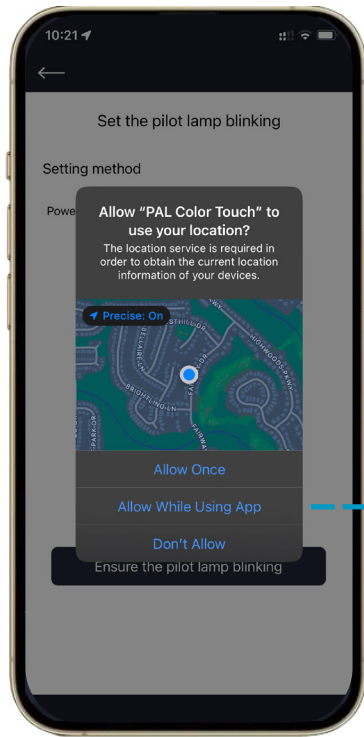

Step 1 Select 'Allow'

Step 2 Enter WiFi Password

Step 3 Select 'Start Configuration'

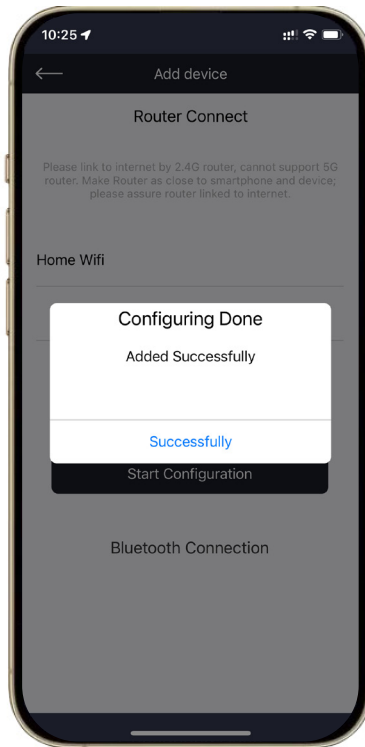
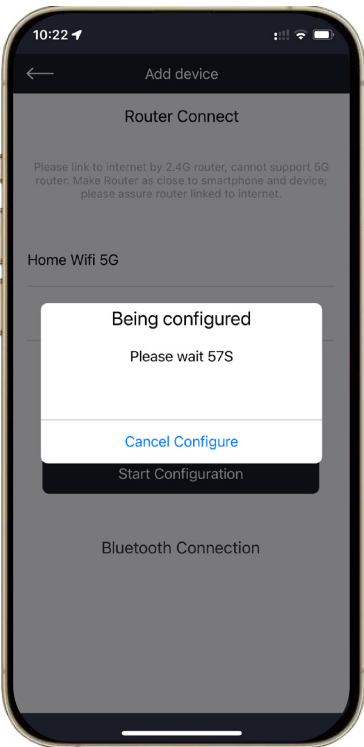
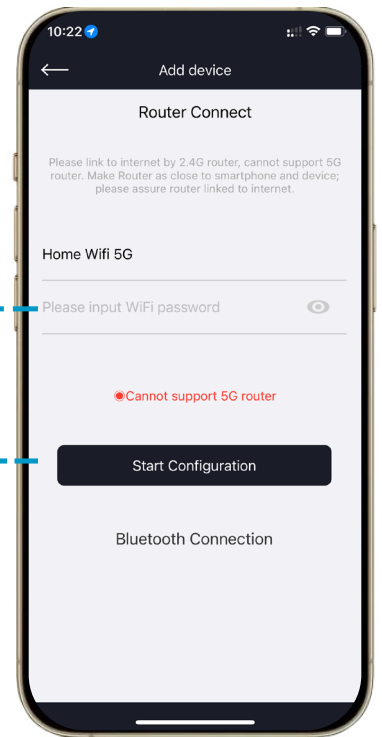

Operating the Color Touch App



Changing Zone Names

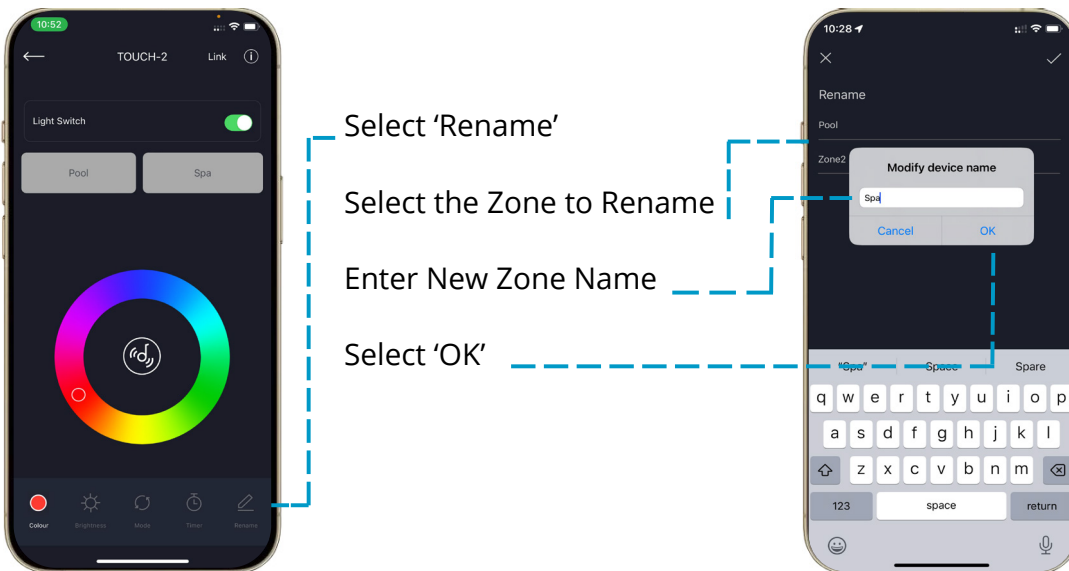

Creating Schedules

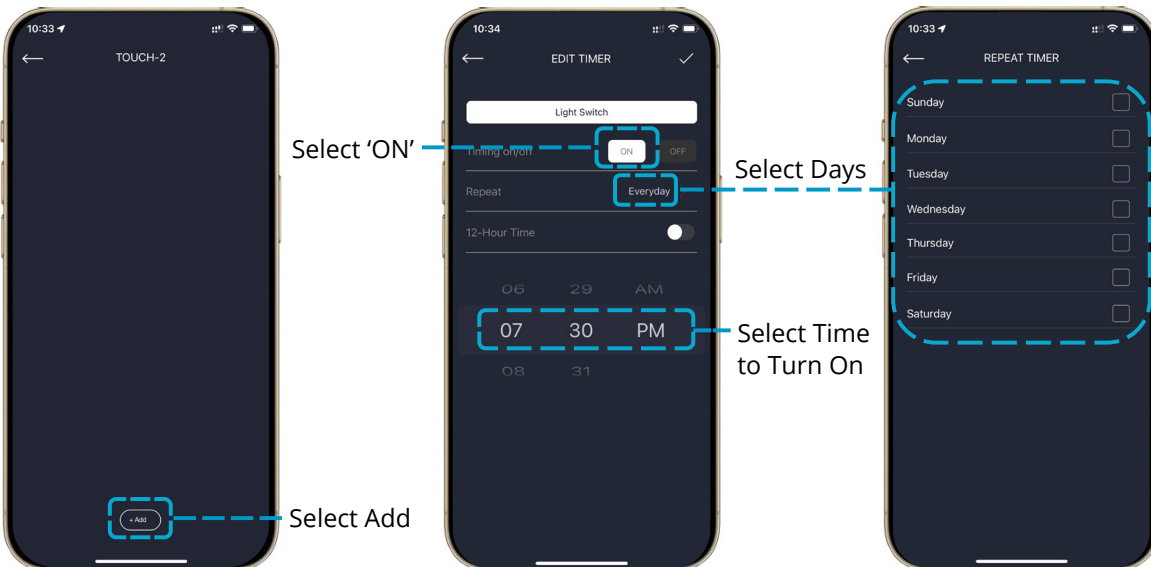

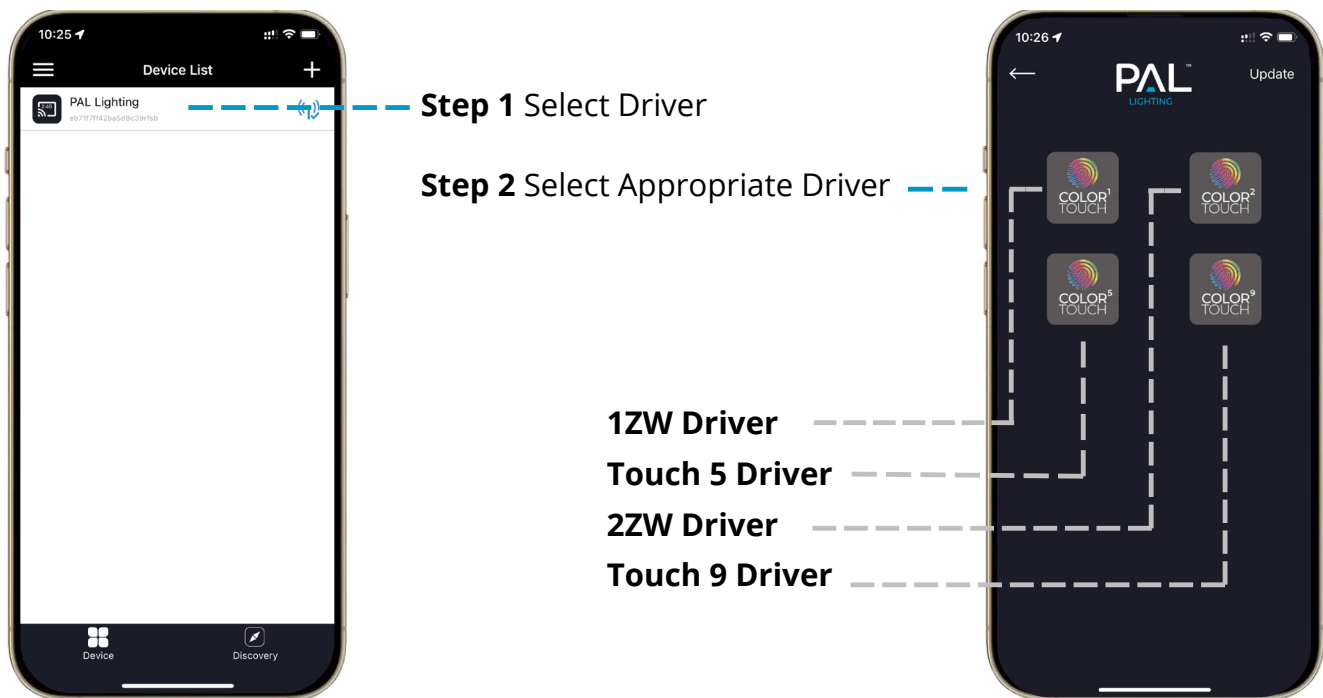

Coding a 1Z & 2Z Driver with a Standalone Wi-Fi Module

1. Connect the Wi-Fi Module to the Driver
 - o Ensure the Wi-Fi module is properly connected to the driver.
2. Download the PAL Color Touch App
 - o Go to your app store and download the PAL Color Touch app.
3. Connect to Wi-Fi
 - o Open the PAL Color Touch app and connect your device to the Wi-Fi network.
4. Add the Driver
 - o In the app, tap the “+” button in the top right corner.
 - o Select “2.4g” from the list of options.
 - o The PAL driver should appear; select it to connect.
5. Link the Driver
 - o Open the app and navigate to “Touch 2.”
 - o Tap the “Link” button in the top right corner.
6. Configure the Transformer
 - o On the transformer, press the “Code Setting” button.
 - o Press the “Link” button on the bottom left of the transformer three times.

Following these steps should help you set up the driver and connect it using the PAL Color Touch app.

